

目 录

一、运输作业组织与管理模块..... 2

二、仓储与配送作业组织与管理模块..... 34

三、国际物流作业组织与管理模块..... 150

四、 快递物流作业组织与管理模块.....	213
-----------------------	-----

湖南商务职业技术学院物流管理专业学生技能考核题库

一、运输作业组织与管理模块

○

○

○

--	--	--

○

○

--	--	--	--	--

() 任务描述

- :
-
-



<input type="checkbox"/> <input type="checkbox"/>				<input type="checkbox"/> <input type="checkbox"/>				
<input type="checkbox"/> <input type="checkbox"/>								
						<input type="checkbox"/> <input type="checkbox"/> <input type="checkbox"/> <input type="checkbox"/>		



() 任务描述:

-
-
-



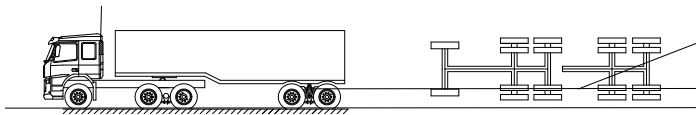
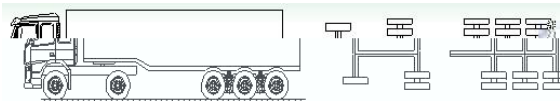

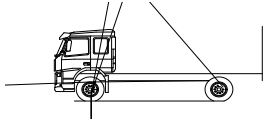
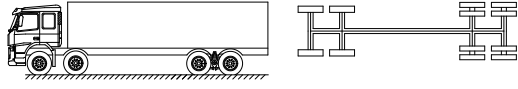
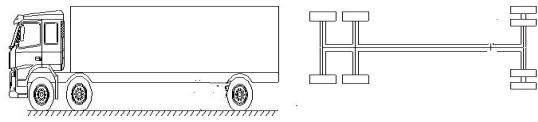

() 任务描述:

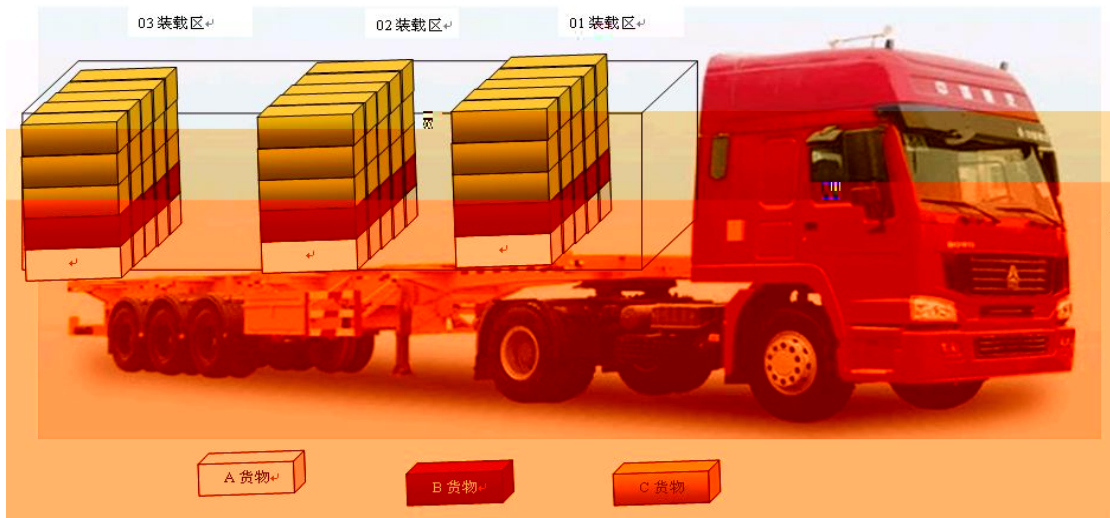

○

○

○

○

○

() 任务描述



D

<input type="checkbox"/> <input type="checkbox"/>			<input type="checkbox"/> <input type="checkbox"/>						
<input type="checkbox"/> <input type="checkbox"/>									
						<input type="checkbox"/> <input type="checkbox"/> <input type="checkbox"/> <input type="checkbox"/>			



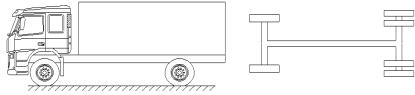
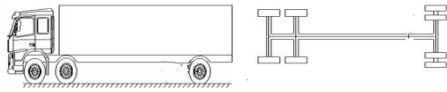
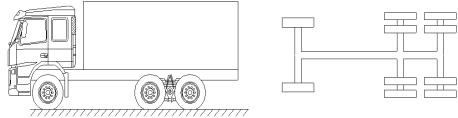

2

3

4

() 任务描述

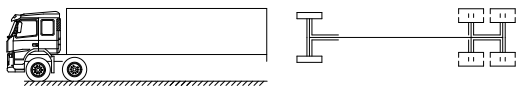
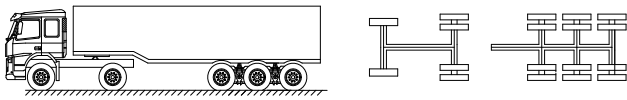
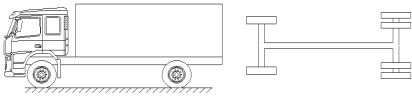



() 任务描述

-
-
-
-
-

() 任务描述

○



Sailing Schedule from : Shenzhen,Shenzhen,Guangdong,China

To : Los Angeles,Los Angeles,CA,United States

Origin City : Shenzhen,Shenzhen,Guangdong,China

CY/DOOR

Destination City : Los Angeles,Los Angeles,CA,United States

CY/DOOR

序列号	航线	船名	航次	截关时间	装货港	预计离港时间	实际离港时间	卸货港
1	YPSW	YM UNISON	59E	2016-04-22 17:00	Yantian	2016-04-25		Los Angeles
2	SEA	NORTHERN JAVELIN	002E	2016-04-23 12:00	Yantian	2016-04-27		Long Beach
3	AAS2	CMA CGM LIBRA	095TXE	2016-04-25 16:00	Yantian	2016-04-28		Long Beach
4	YPSW	YM UBIQUITY	22E	2016-04-29 17:00	Yantian	2016-05-02		Los Angeles
5	SEA	C SCL PUSAN	117E	2016-04-30 12:00	Yantian	2016-05-04		Long Beach
6	AAS2	CMA CGM COLUMBA	097TXE	2016-05-02 16:00	Yantian	2016-05-05		Long Beach
7	SEA	COSCO NINGBO	069W	2016-05-06 11:00	Yantian	2016-05-08		Long Beach
8	YPSW	YM JIREBY	50E	2016-05-06 17:00	Yantian	2016-05-09		Los Angeles
9	SEA	COSCO EXCELLENCE	027E	2016-05-07 12:00	Yantian	2016-05-11		Long Beach
10	AAS2	CMA CGM CENTAURUS	099TXE	2016-05-09 16:00	Yantian	2016-05-12		Long Beach
11	YPSW	YM MASCULINITY	32E	2016-05-13 17:00	Yantian	2016-05-16		Los Angeles
12	SEA	HONG KONG BRIDGE	039E	2016-05-14 12:00	Yantian	2016-05-18		Long Beach
13	AAS2	CMA CGM THALASSA	101TXE	2016-05-16 16:00	Yantian	2016-05-19		Long Beach



干货箱



	箱体内部尺寸			箱体内容积及载重量		箱门开度尺寸	
	L	W	H	Cu	P	W	H
20'	5898	2352	2393	33.2	21740/28230#	2340	2280
40'	12032	2352	2393	67.7	26630	2340	2280
HC	12032	2352	2698	76.3	26520	2340	2585

冷藏箱



	箱体内部尺寸			箱体内容积及载重量	
	L	W	H	Cu	P
20'	5444	2284	2267	28.5	21135/27160#
40'	11583	2284	2250	58.7	26580
HC	11583	2284	2550	67.9	26380

开顶箱



	箱体内部尺寸			箱体内容积及载重量	
	L	W	P	Cu	P
20	5900	2330	2337	32.6	21740
40	12025	2330	2337	65.8	26410

○

○

() 实施条件

() 考核时量

() 评分细则

1

() 任务描述



		<input type="checkbox"/>	<input type="checkbox"/>	<input type="checkbox"/>	<input type="checkbox"/>

□		□		
□		□		



() 实施条件

() 考核时量

() 评分细则

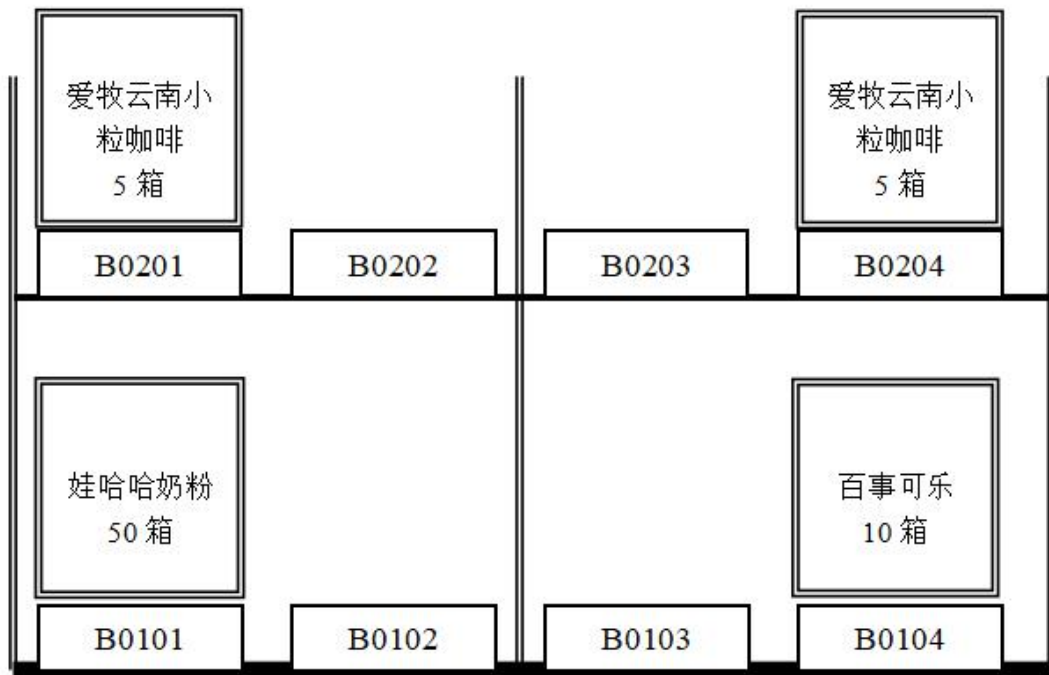
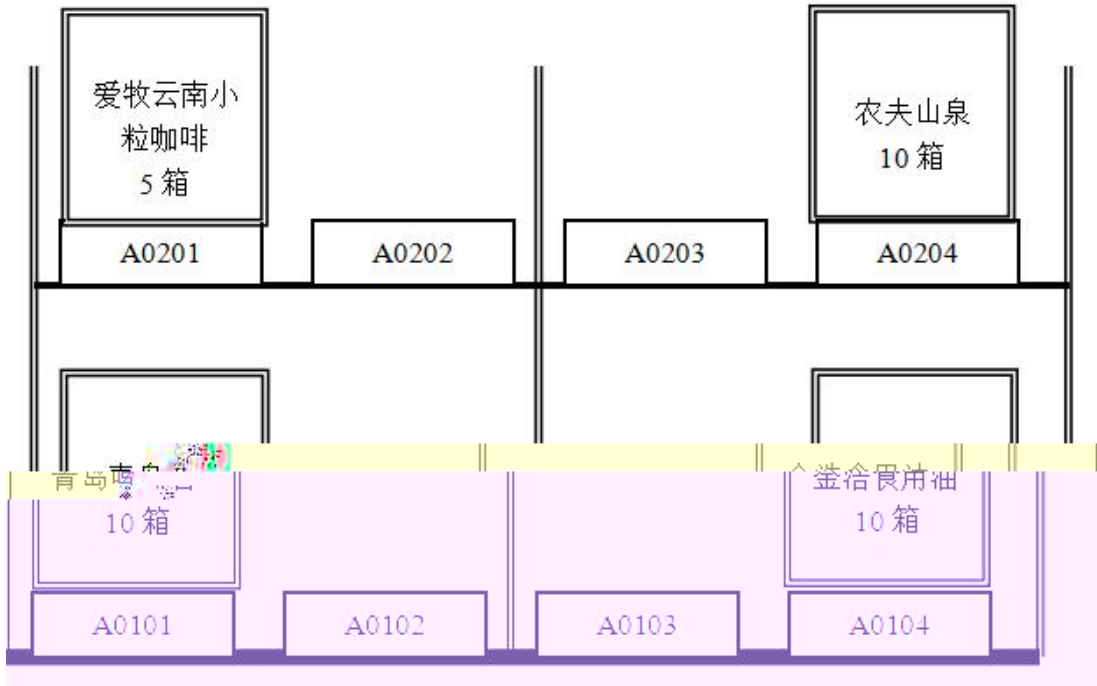

产品运输单

-
-
-
-
-
-
-
-

80				

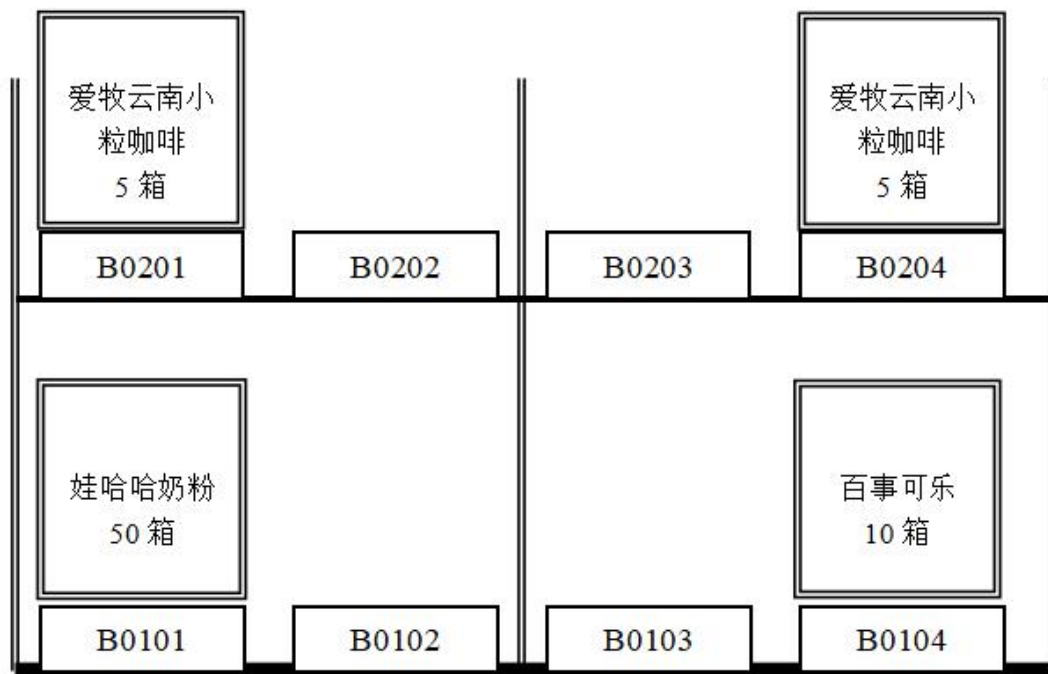
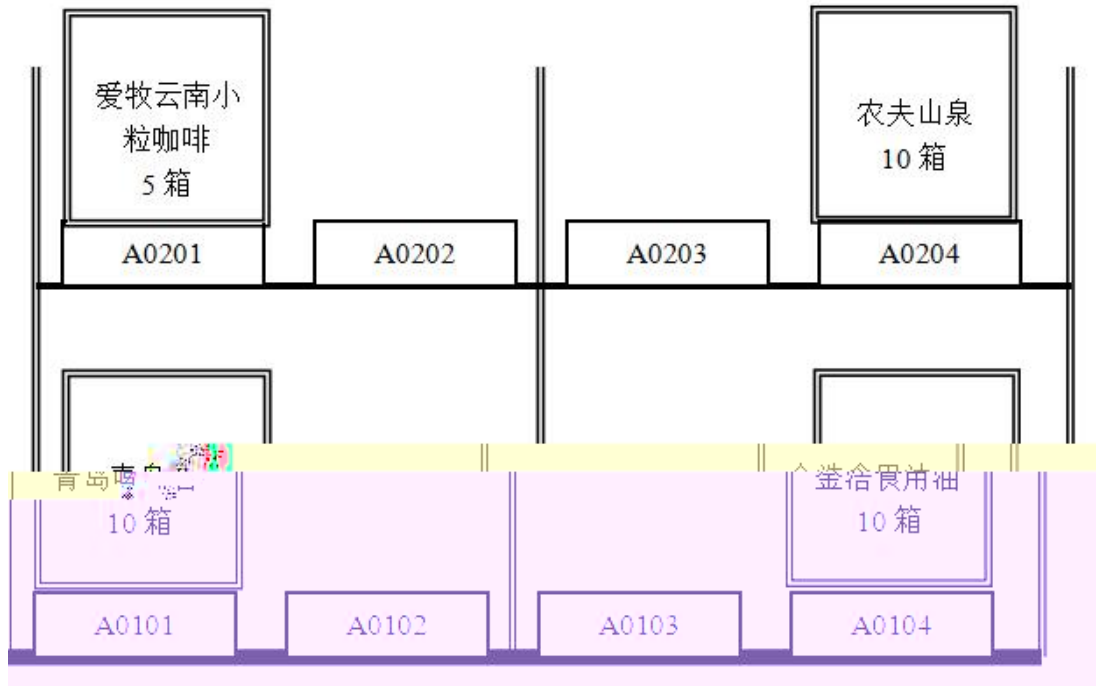

产品运输单

-
-
-
-
-
-
-
-

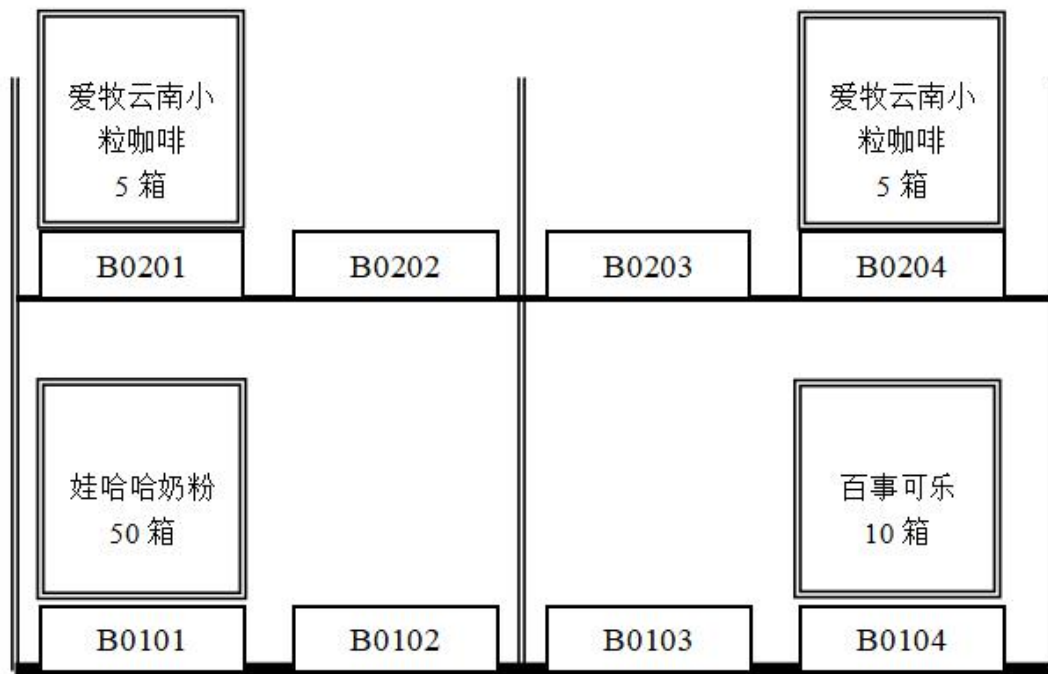
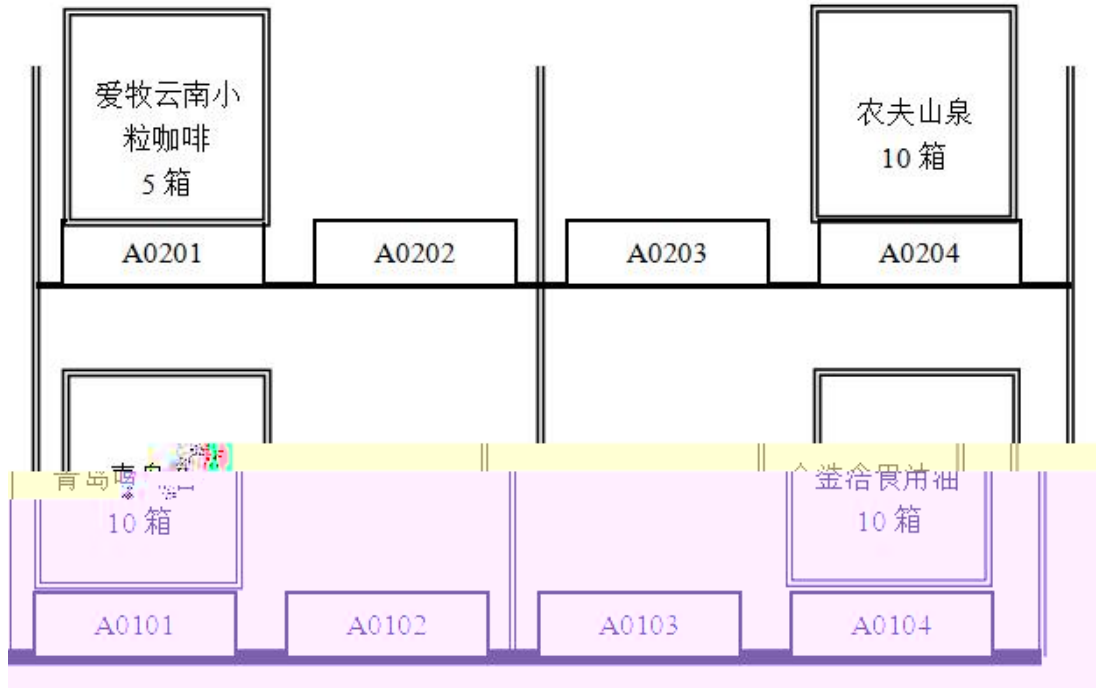

产品运输单

-
-
-
-
-
-
-
-

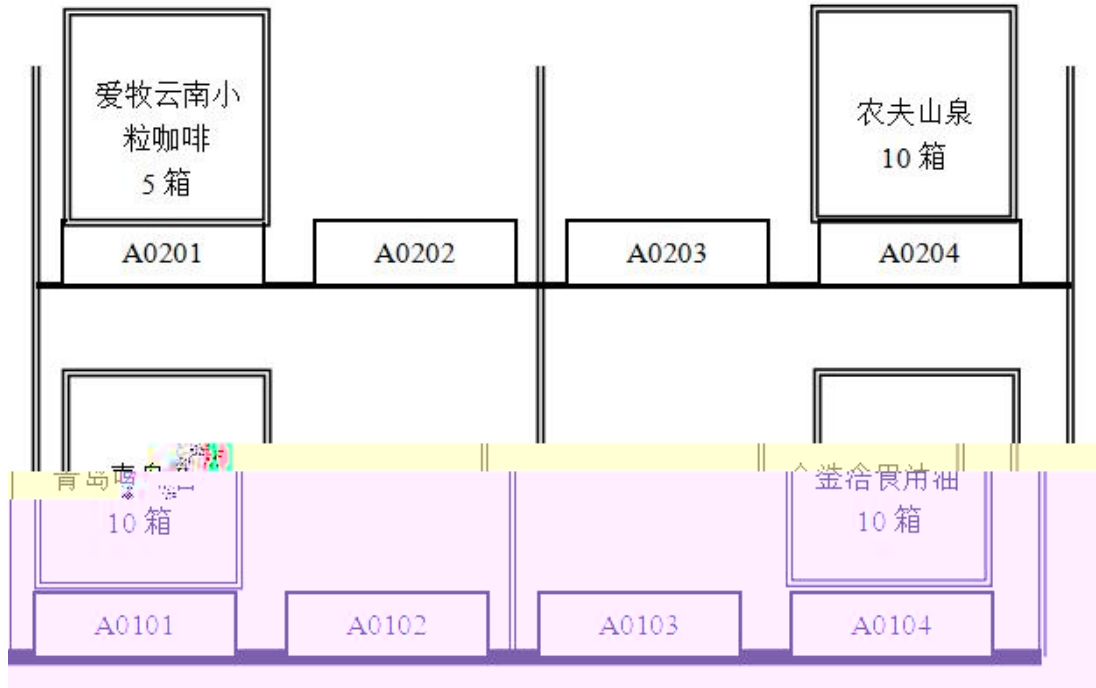

产品运输单

-
-
-
-
-
-
-
-

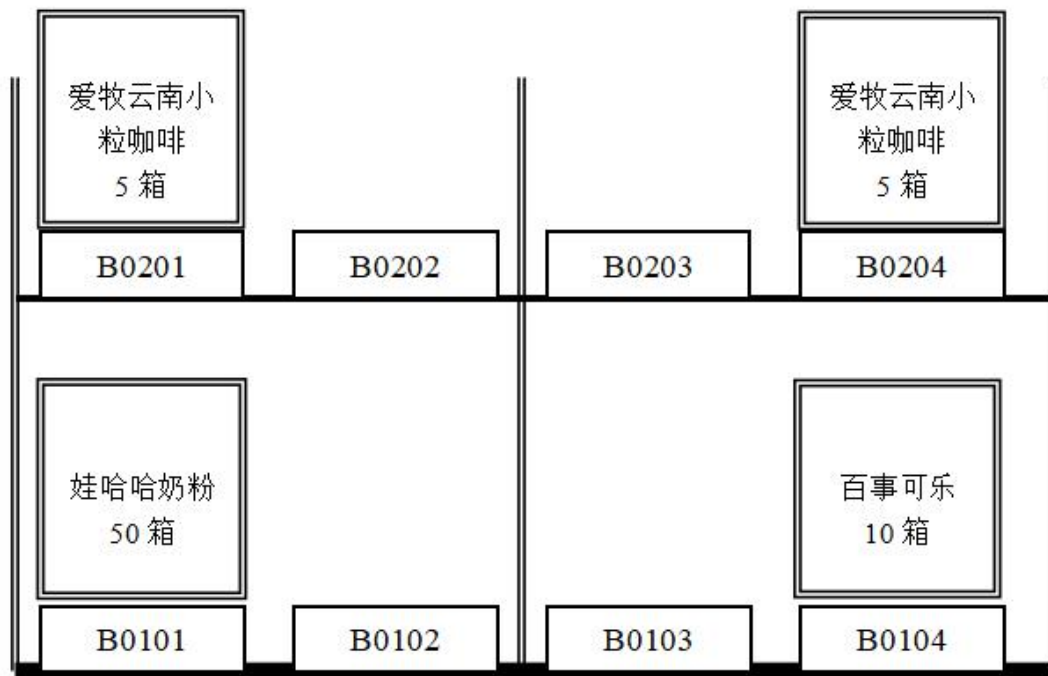
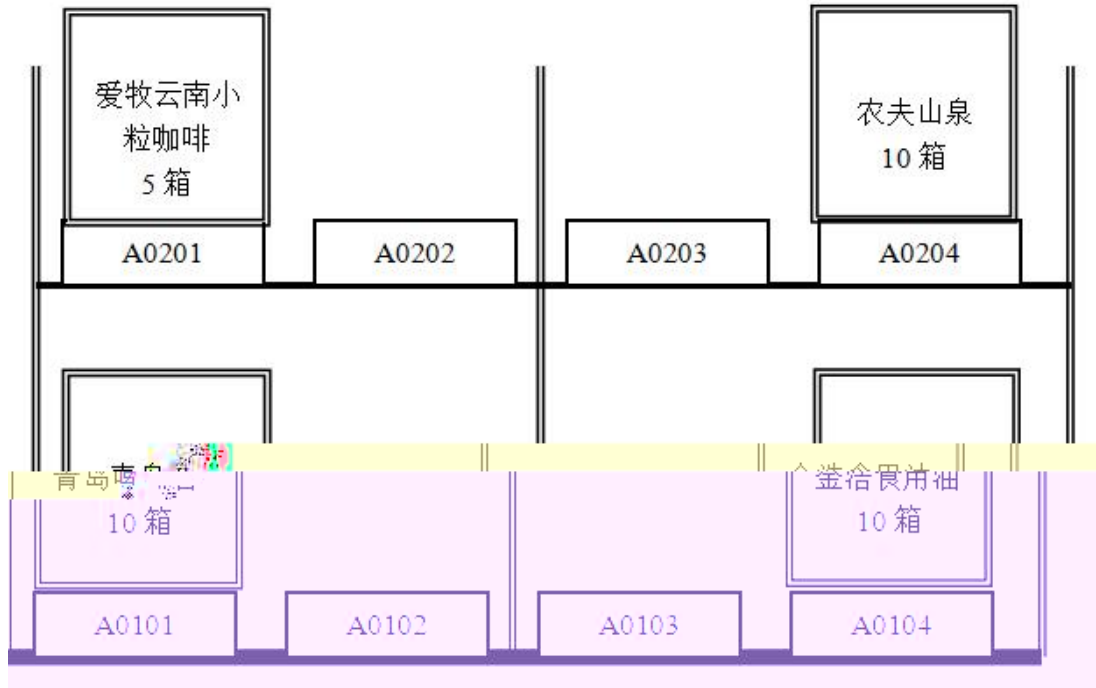

产品运输单

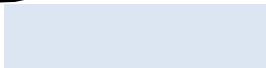

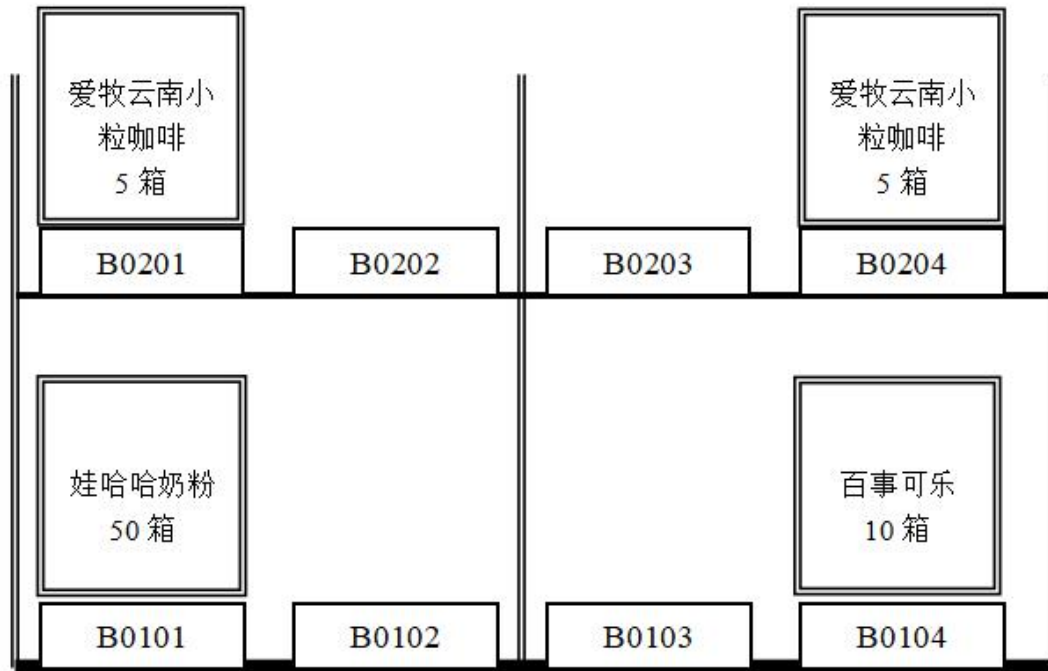
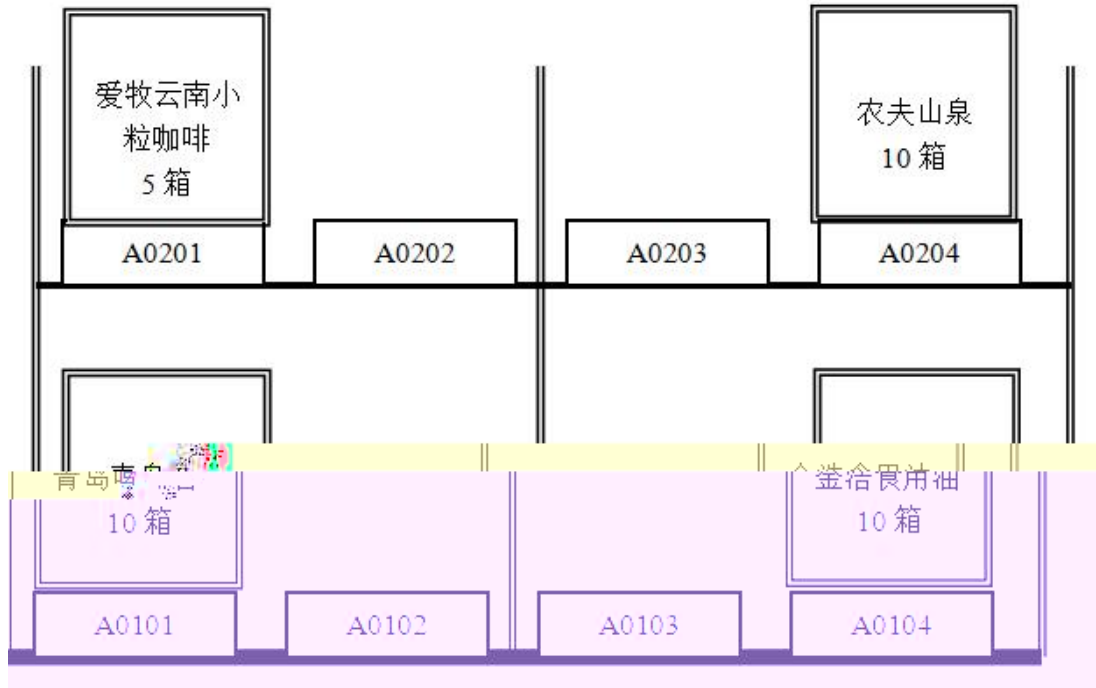

产品运输单

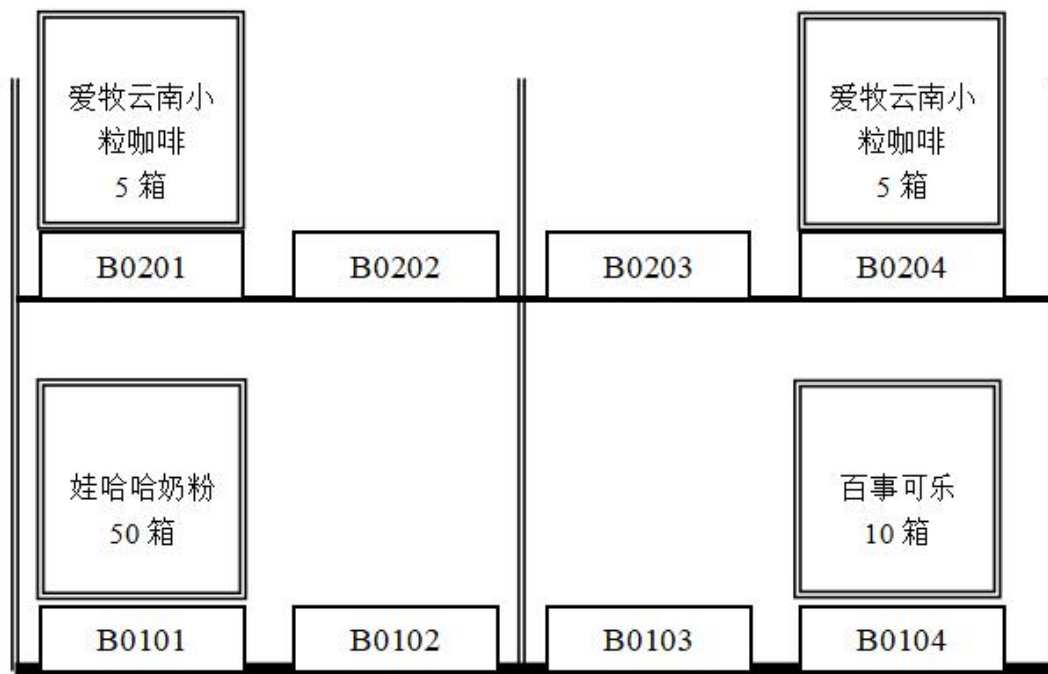
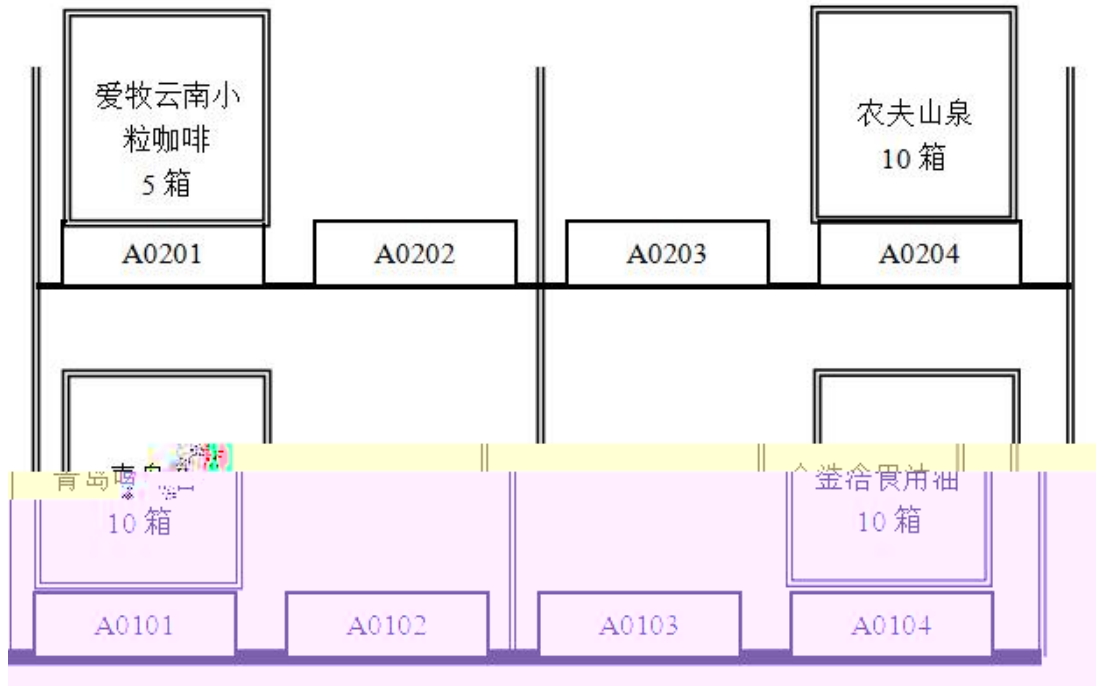

产品运输单

-
-
-
-
-
-
-
-
-

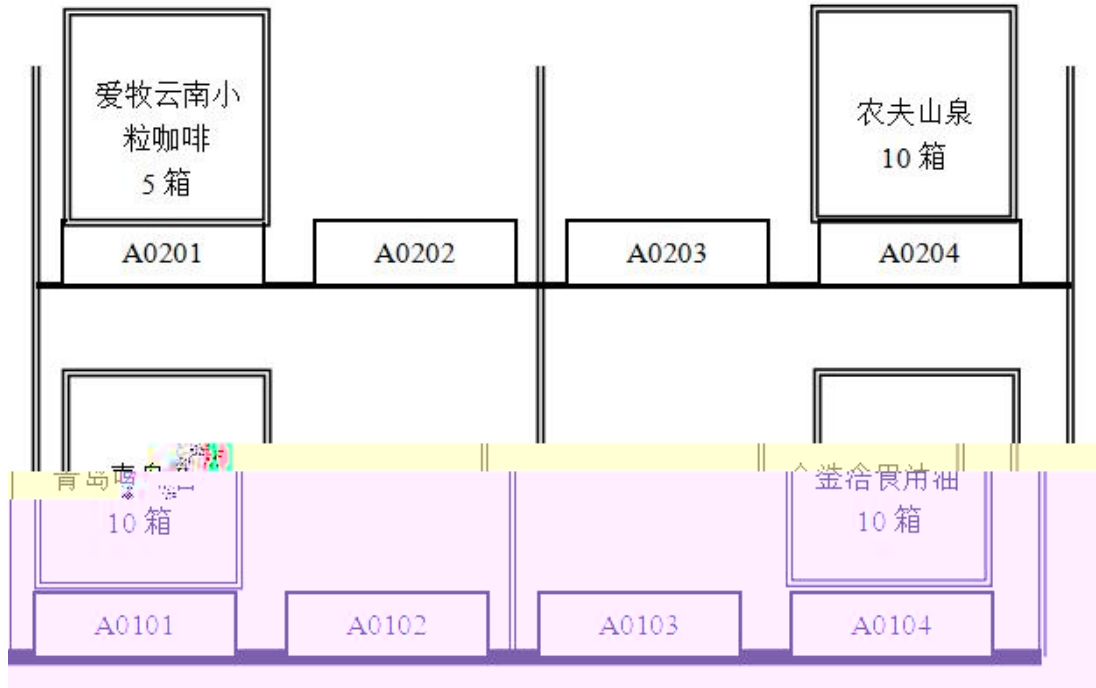

产品运输单

-
-
-
-
-
-
-
-

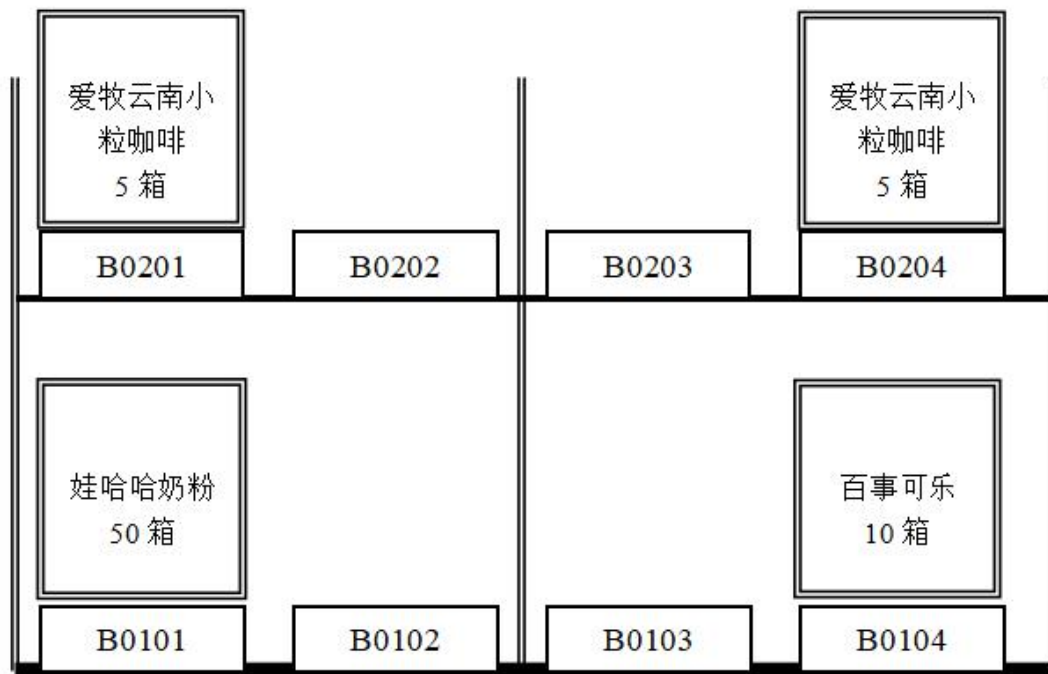
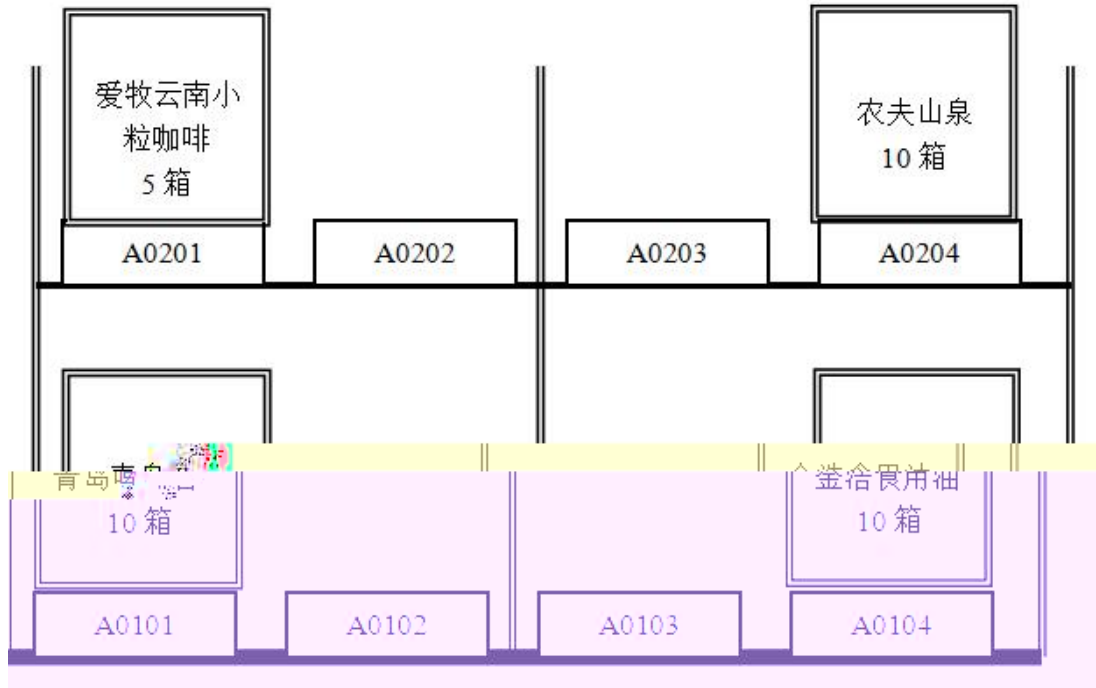

产品运输单

-
-
-
-
-
-
-
-
-

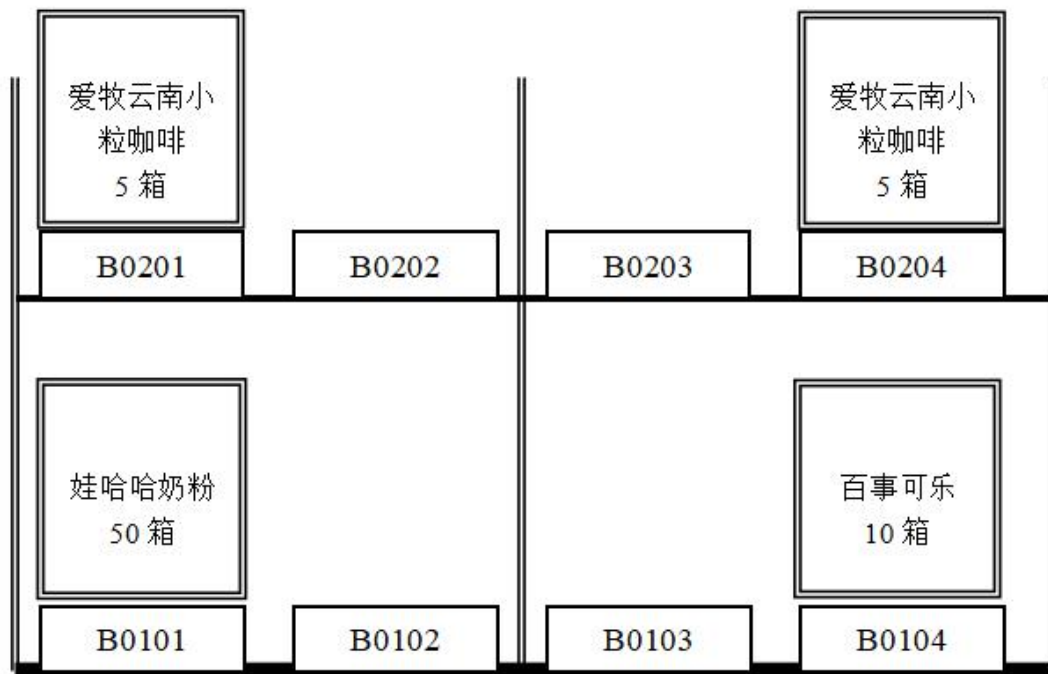
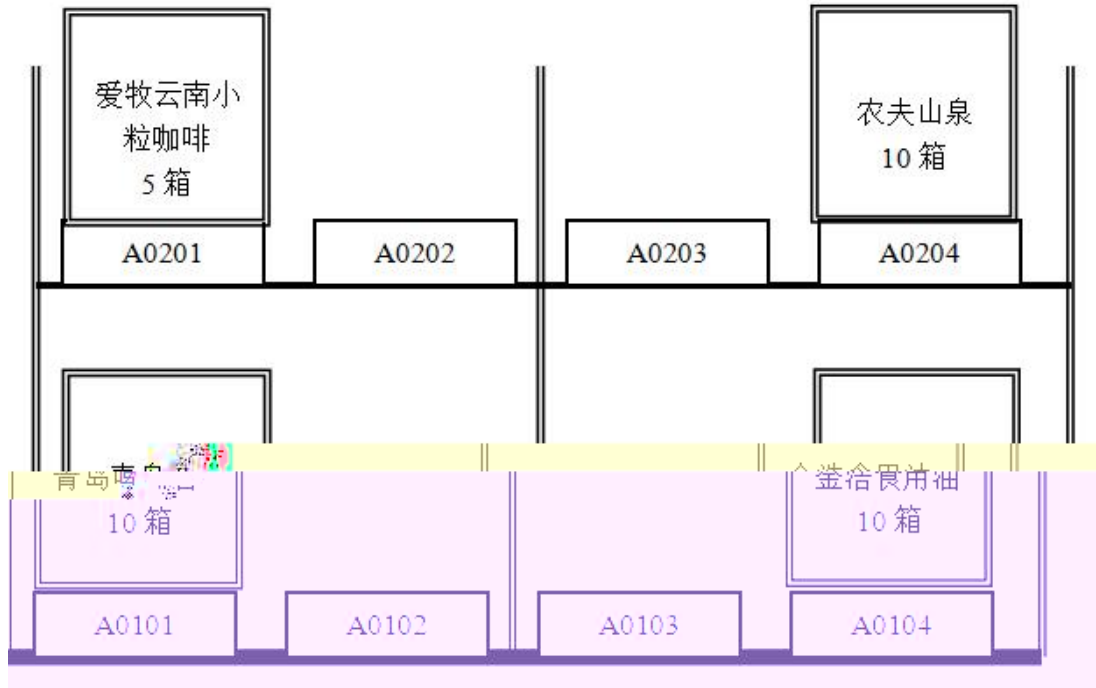

产品运输单

-
-
-
-
-
-
-
-

○

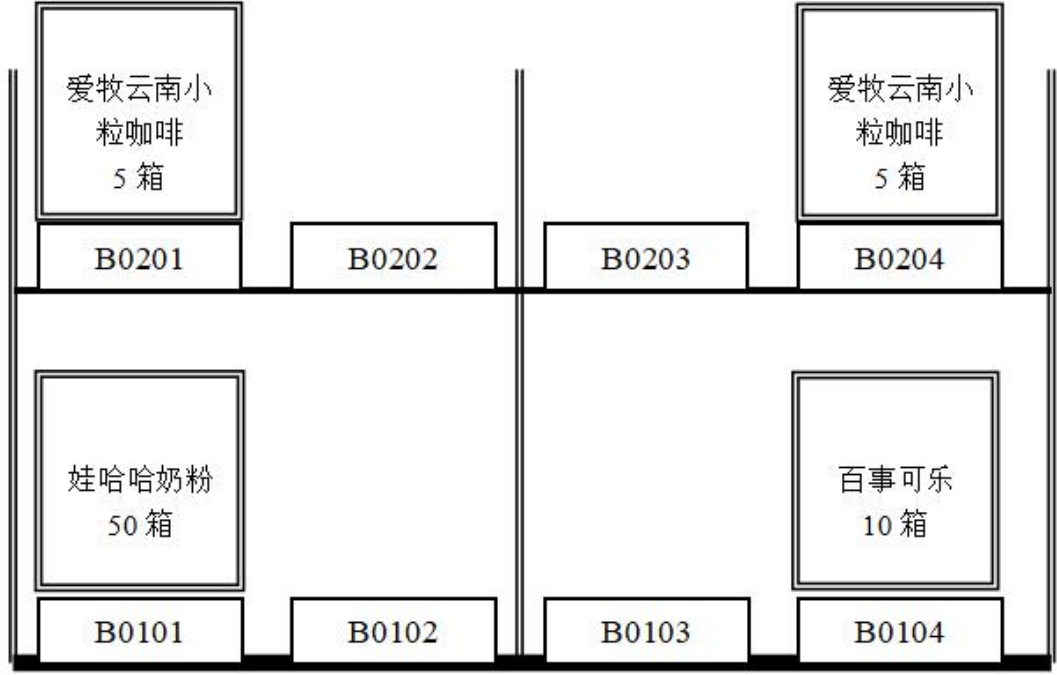
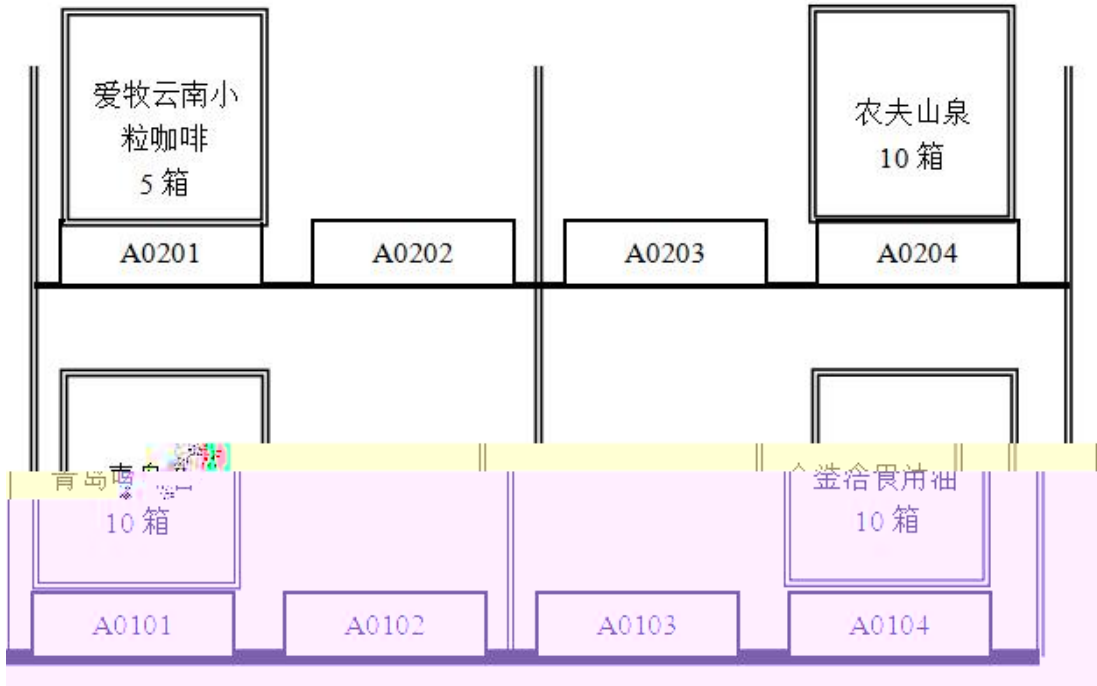



--	--	--	--	--	--

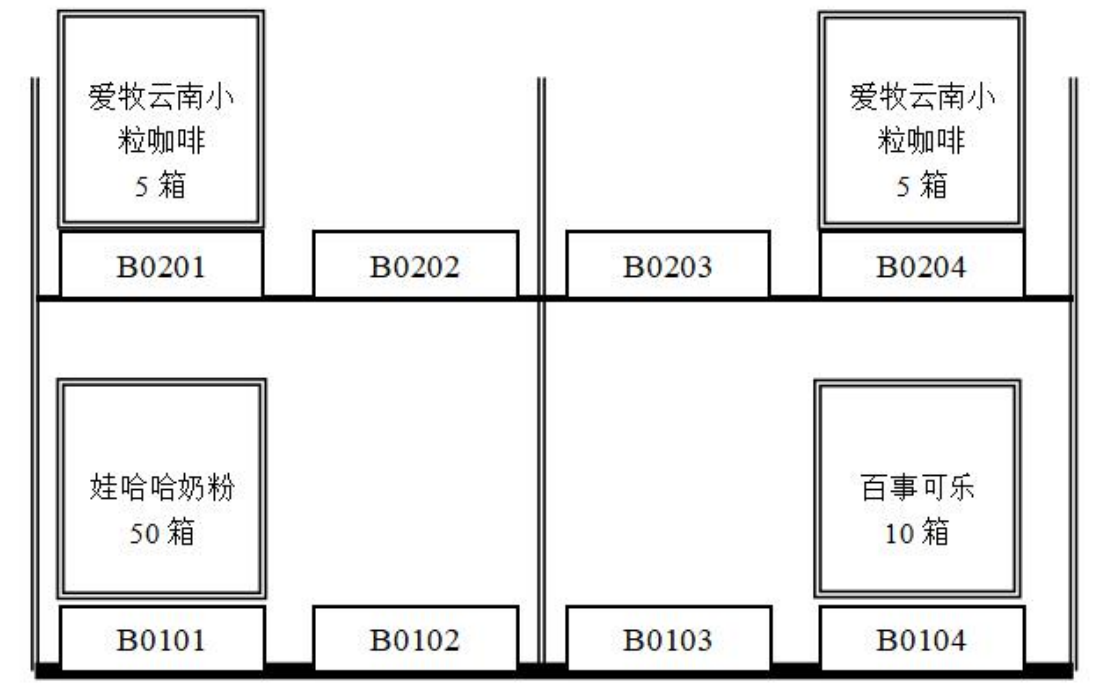
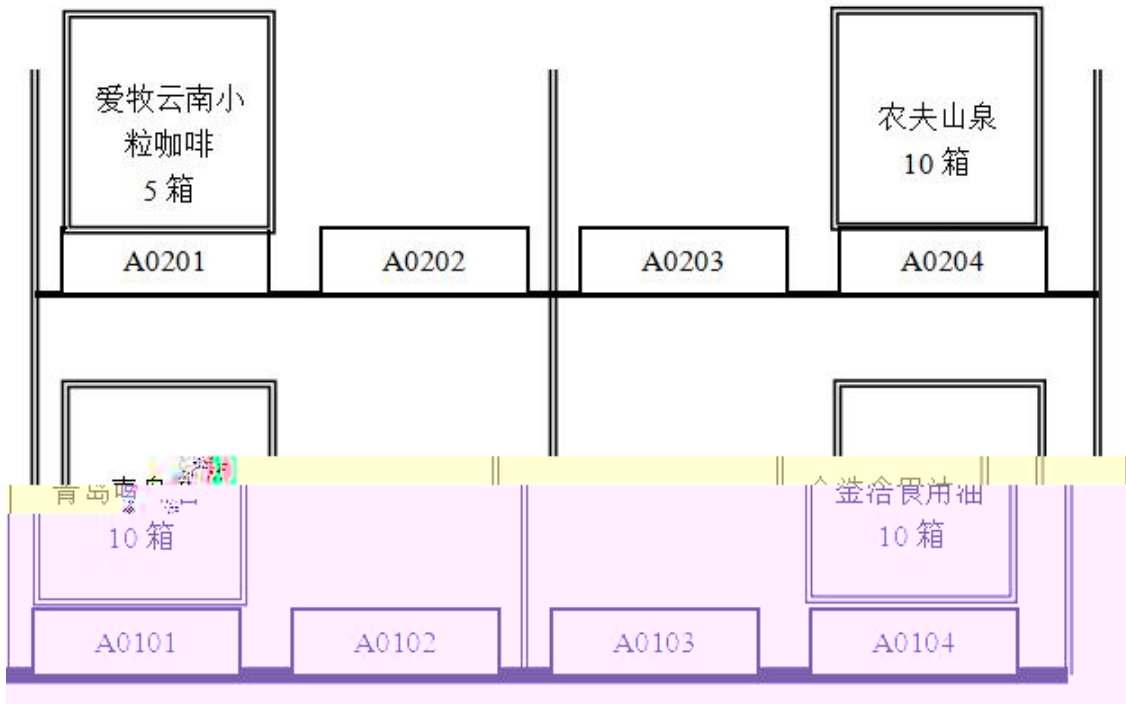

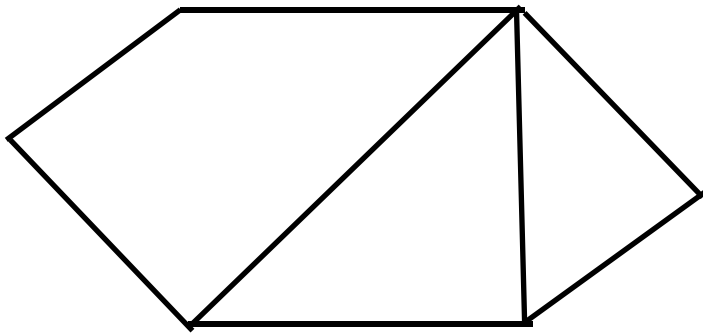

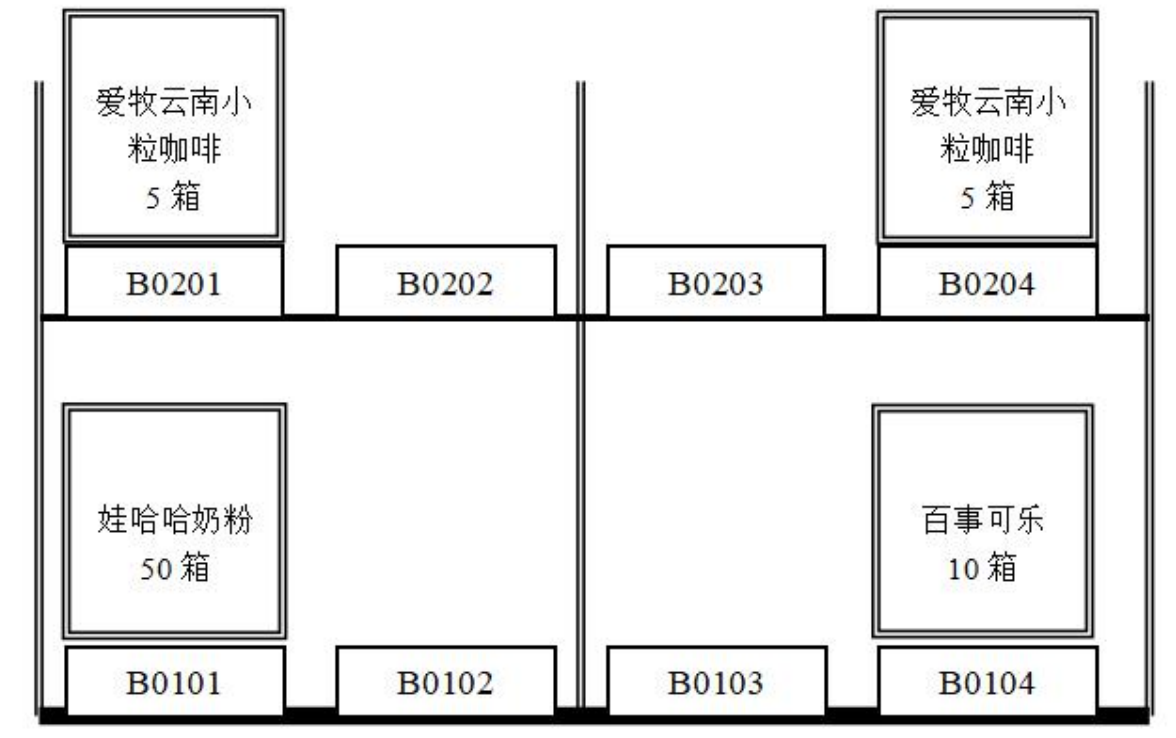
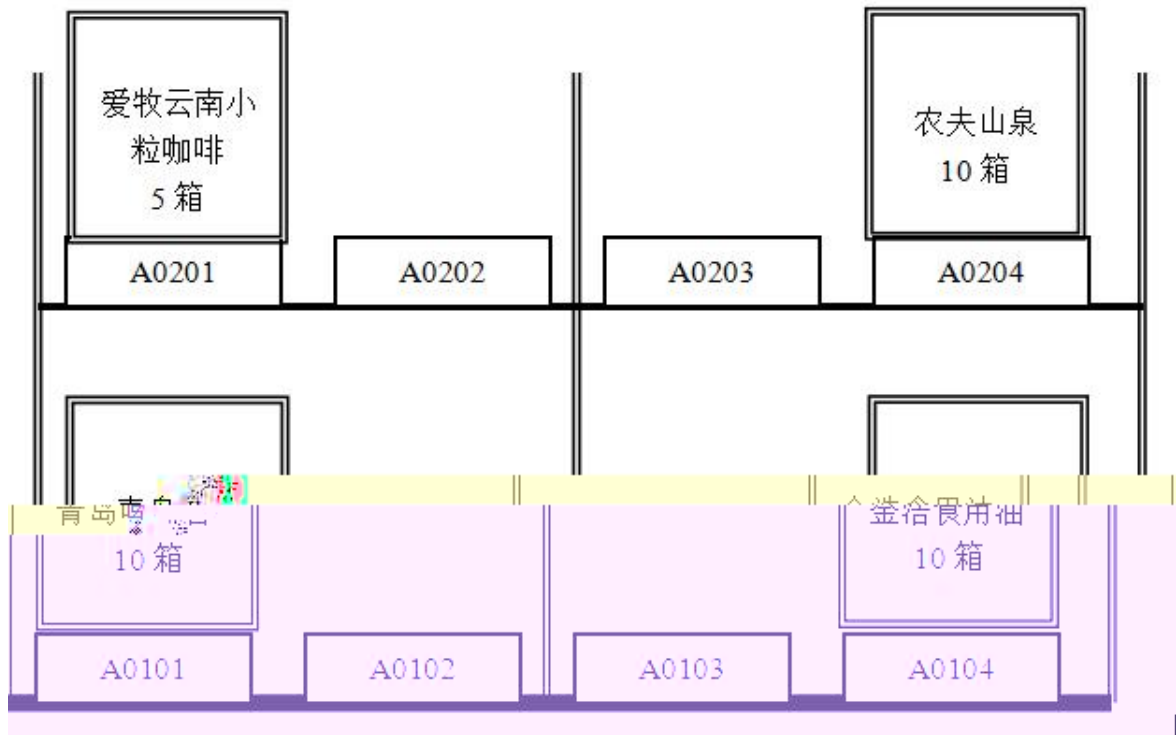

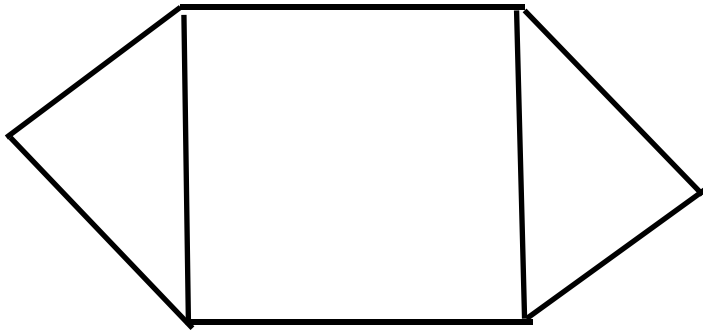

1

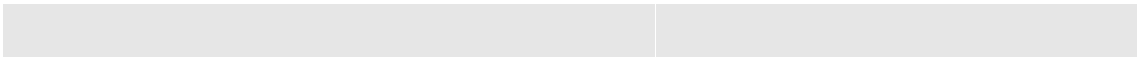

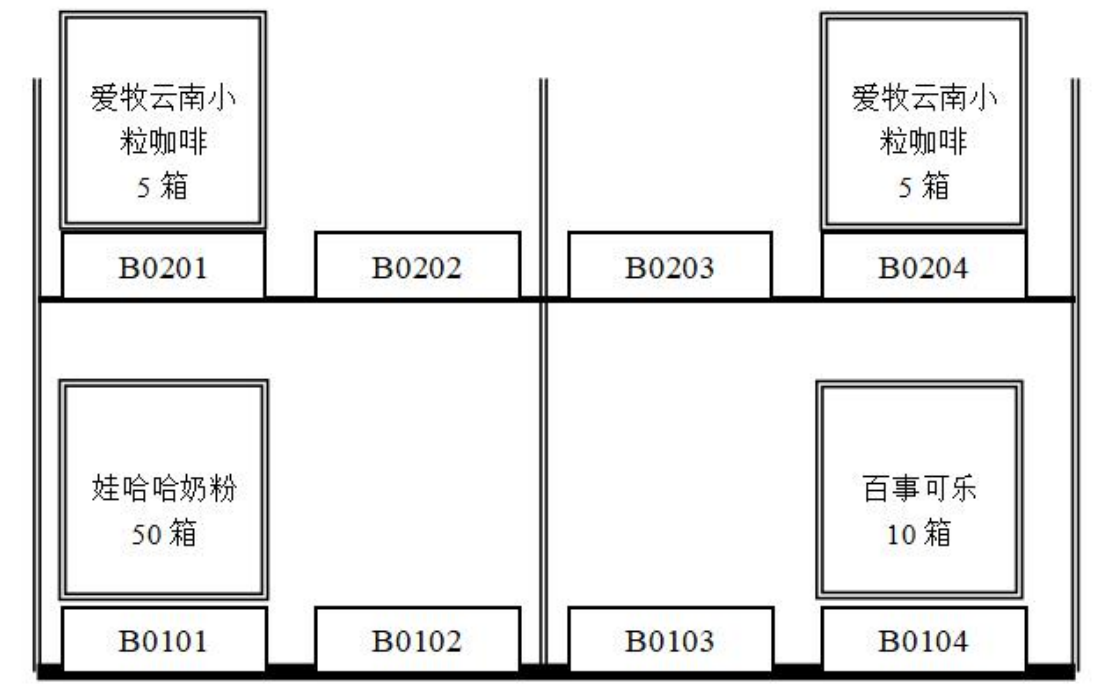
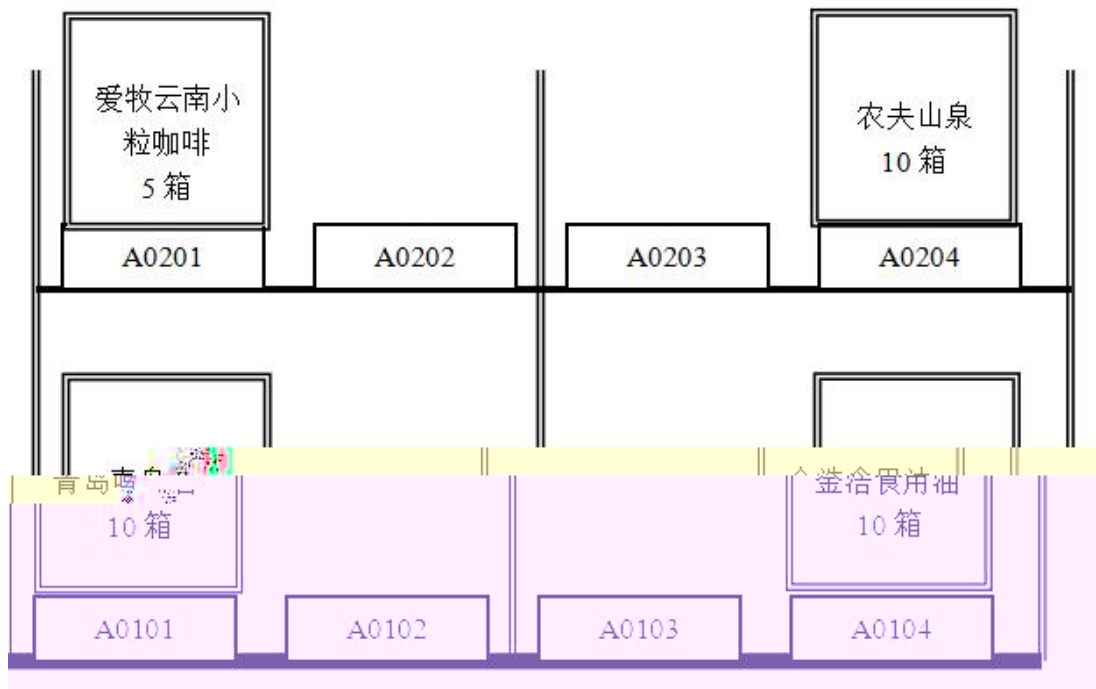

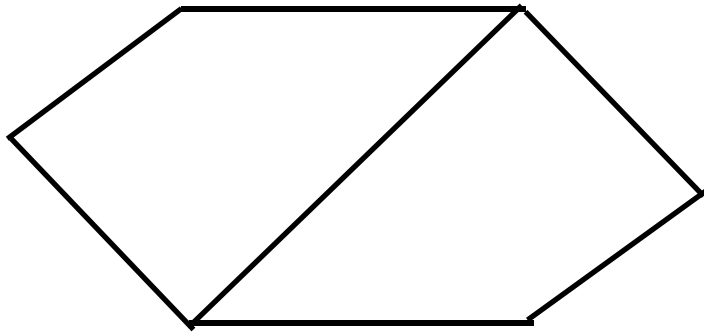

1

--	--	--	--	--	--

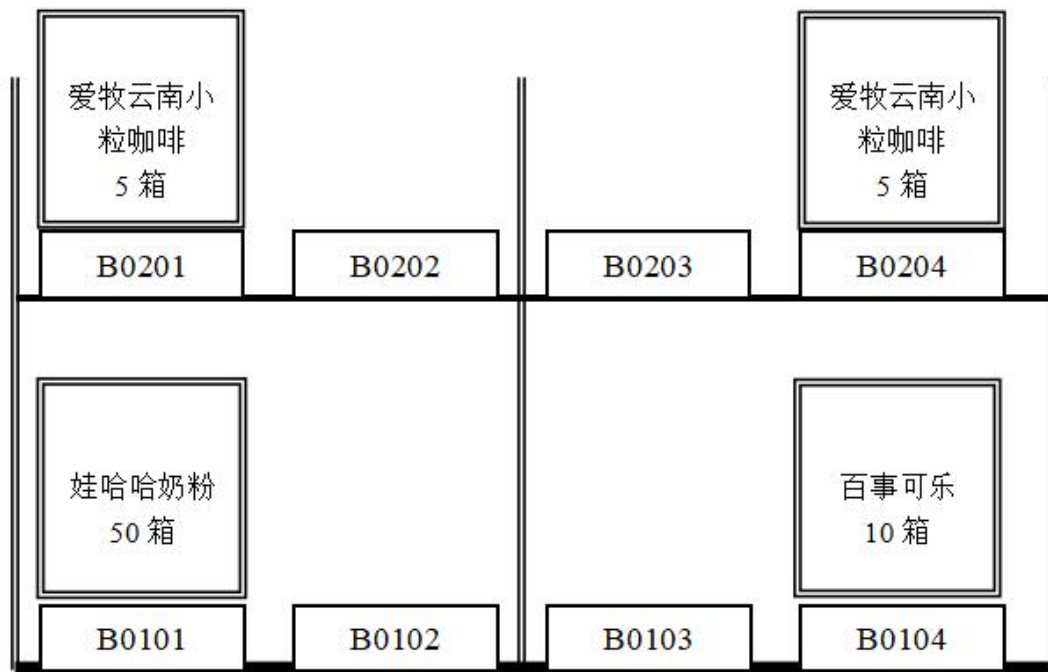
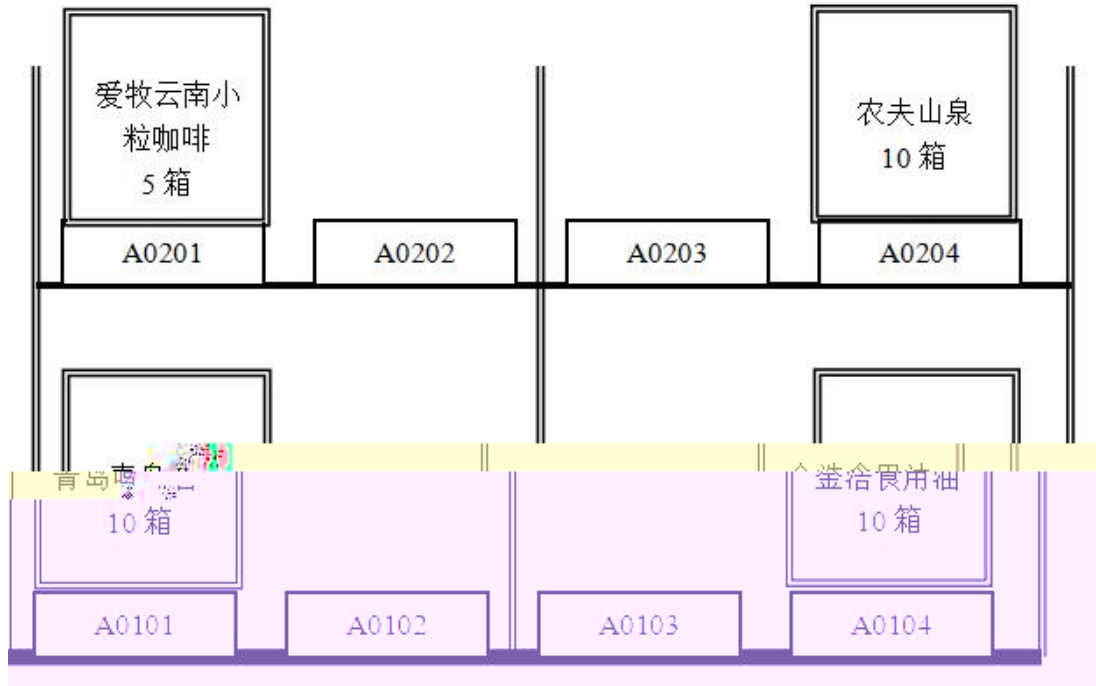

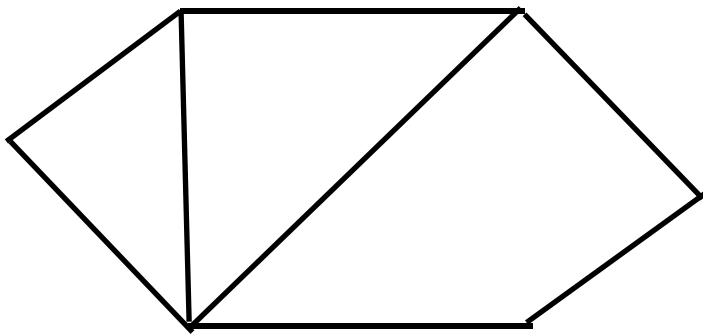

○

○

○

○

!

@

!

○

○

○

○

--	--

○

○

三、国际物流作业组织与管理模块

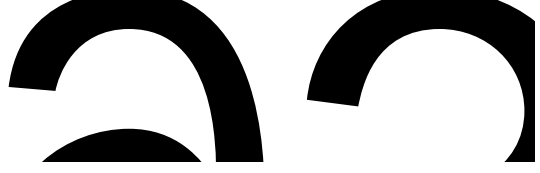



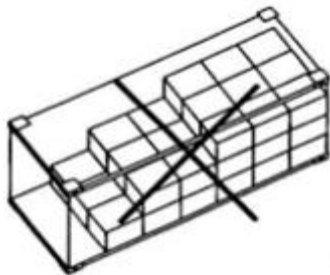
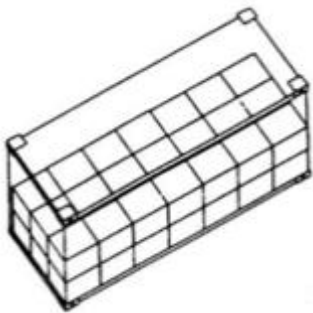

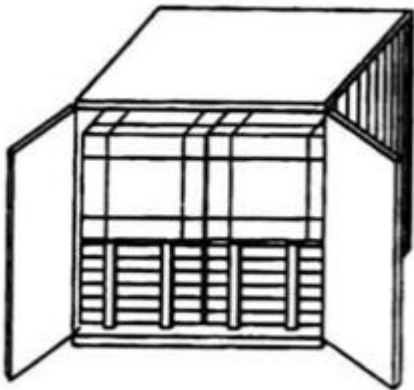
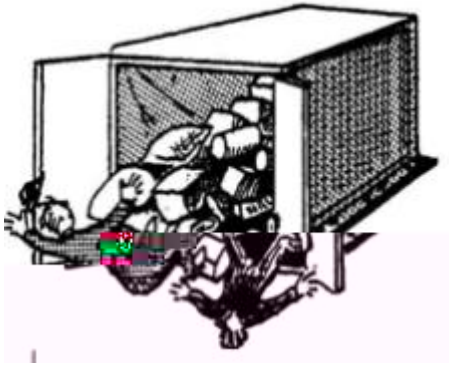
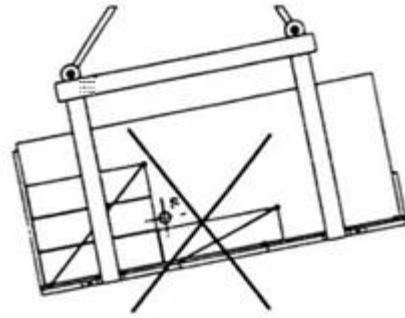





○





○

船公司 Carrier	船名/航次	服务代码	航线	装船港/卸船港	启-达日期	天	挂港
							
							
							
							
							
							
							
							
							
							

○
○

BEIJING	CN		BJ\$
Y. RENMINBI	CNY		KGS
BOSTON	US	M	630.00
		N	79.97
		45	60.16
		100	53.19
		300	45.80

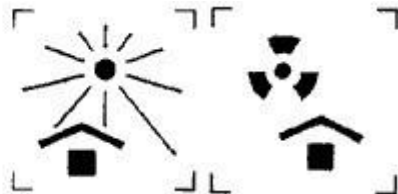
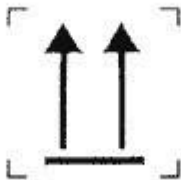
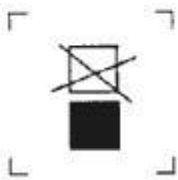

○

○

○

集装箱设备交接单
EQUIPMENT INTERCHANGE RECEIPT

OUT 出场

No. _____

用箱人/运箱人 (CNTR. USER/AULIER)		提箱地点 (PLACE OF DELIVERY)	
发往地点 (DELIVERED TO)		返回/收箱地点 (PLACE OF RETURN)	
船名/航次 (VESSEL/VOYAGE No.)	集装箱号 (CNTR. No.)	尺寸/类型 (SIZE/TYPE)	营运人 (CNTR. OPTR)
船名/航次 (VESSEL/VOYAGE No.)	集装箱号 (CNTR. No.)	箱封号 (SEAL No.)	箱封号 (SEAL No.)
进箱日期 (DATE IN)	出箱日期/状态 (DATE OF GATE-OUT/STATUS)	进箱日期/状态 (DATE OF GATE-IN/STATUS)	出箱日期 (DATE OUT)
交接地点记录 (INSPECTION AT THE TIME OF INTERCHANGE)			
普通集装箱 (GP. CNTR.)	冷藏集装箱 (R. CNTR.)	特种集装箱 (SPL. CNTR.)	发电机 (GEN. SET)
<input type="checkbox"/> 正常 (SOUND)	<input type="checkbox"/> 正常 (SOUND) 设定温度 (SET)	<input type="checkbox"/> 正常 (SOUND)	<input type="checkbox"/> 正常 (SOUND)
<input type="checkbox"/> 异常 (DEFECTIVE)	<input type="checkbox"/> 异常 (DEFECTIVE) 记录温度 (RECORDED)	<input type="checkbox"/> 异常 (DEFECTIVE)	<input type="checkbox"/> 异常 (DEFECTIVE)

损坏记录及代号 (DAMAGE CODE)

BR 破损 (BROKEN)	D 凹痕 (DENT)	M 丢失 (MISSING)	DR 污损 (DIRTY)	DL 无标 (DGLABEL)
-----------------------------	--------------------------	-----------------------------	----------------------------	------------------------------

左侧 (LEFT SIDE)



右侧 (RIGHT SIDE)

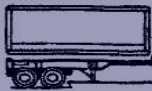

前端 (FRONT)



内部 (INSIDE)



顶部 (TOP)

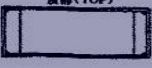

底部 (FLOOR BASE)



后端 (REAR)



如有异常, 请注明程度及尺寸 (REMARK)

除列明者外, 集装箱设备交接时完好无损, 密封完整无损。
CONTAINER EQUIPMENT INTERCHANGED IN SOUND CONDITION AND SEAL INTACT UNLESS OTHERWISE STATED

用箱人/运箱人签署 (CONTAINER USER/AULIER'S SIGNATURE)	码头/堆场值班员签署 (TERMINAL/DEPOT CLERK'S SIGNATURE)
____年____月____日	____年____月____日

GB/T 14161-1996 格式印制



--	--	--	--	--	--

--	--	--

--	--	--	--	--	--

--	--	--	--	--	--

--	--	--	--	--	--	--	--

○



○

--	--	--

--	--	--	--	--	--

○

○

○

Ö

○

四、 快递物流作业组织与管理模块

--	--	--	--	--	--

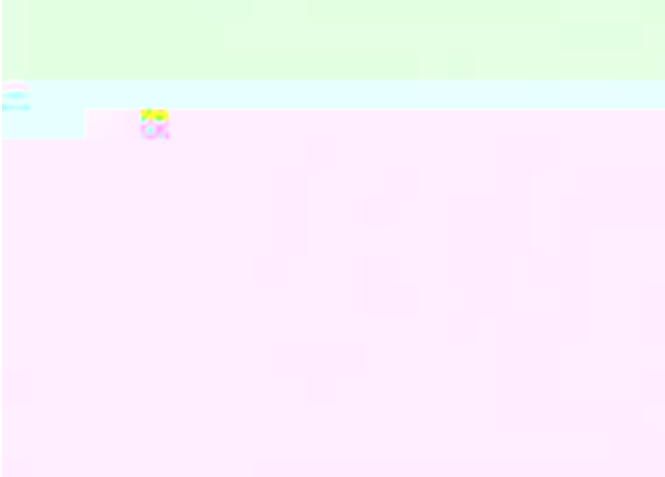
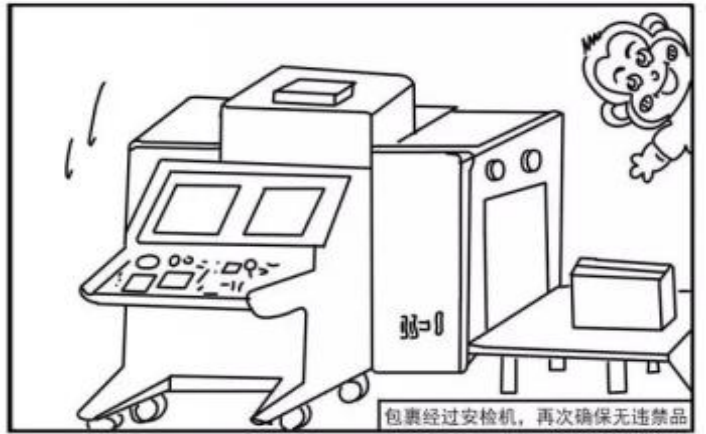

--	--	--	--	--	--

--	--	--	--	--	--

[想知道: 中国成都理工大学校园快递具体在哪? 百度知道](#)

3个回答 - 提问时间: 2014年02月10日

最佳答案  均在银杏后面。宝盒、圆通、顺丰在电影院后面。中通、申通在图书馆下面。常用的是这几个。

zhidao.baidu.com/link?... 2014-02-15 - 百度快照 - 80%好评

--	--	--	--

--	--	--	--

1

<hr/>
